



VIRTUAL TRIAL COMPANION HANDBOOK

Canadian Association of Rally Obedience

April 1, 2023

Contents

Welcome CARO Virtual Trial Enthusiasts! 5

1.0 General Information 6

2.0 General Rules 6

 2.1 Eligibility to participate 6

 2.2 Course modifications 6

 2.3 Trial Classes and Streams 6

 2.4 Trials 6

 2.5 Trial Etiquette 6

 2.6 Titles & Ribbons 6

3.0 Rally Classes 7

 3.1 All Rally classes are available in the virtual trials. 7

 3.2 Excluded station signs 7

4.0 Working Classes 7

 4.1 All Working classes are available in the virtual trial. 7

 4.2 Adjustments to rules for the Working Exercises. 7

5.0 Setting up 8

 5.1 Ring set up – Rally and Working Classes 8

 5.2 Station Signs 8

 5.3 Flooring 8

6.0 Rally course setup 9

 6.1 Placement of station signs 9

 6.2 Stations with pylons 9

 6.3 Rally Obstacles with send zones 9

 6.4 Stations with 5ft lines 10

 6.5 Adjustment for Brace 10

7.0 Working course setup 11

 7.1 Station Signs 11

 7.2 Lines and boxes 11

 7.3 Layout of exercises 11

 7.4 Managing equipment during the run. 12

8.0 Videos 13

 8.1 General requirements 13

8.2	Preparing to record	13
8.3	While recording.....	13
8.4	Editing	13
8.5	Submitting videos.....	14
9.0	Judging	14
10.0	Entry of results	14
ANNEX	- Working Exercise Graphics.....	15

Welcome CARO Virtual Trial Enthusiasts!

This companion handbook has been designed for use in conjunction with the Rally and Working Handbooks. It contains rules for participating in the CARO Virtual Trials and the exceptions to the general rules contained in the main handbooks. **These rules and rule exceptions are for CARO Virtual Trials only. Participants are responsible for knowing all rules related to the CARO Virtual Trials.**

This handbook is effective as of August 1, 2023.

If you notice something that is incorrect, please email boardofdirectors@canadianrallyo.ca

Thank you and Rally On!
The 2023 CARO Board of Directors

Copyright

Please note! All signs, written handbooks, forms, and the logo of the Canadian Association of Rally Obedience are protected by copyright laws. Use of these materials for profit is expressly prohibited. Use of the logo may be permitted with the express written permission by the organization.

1.0 General Information

- This handbook includes the exceptions to the Rally and Working rules for the purposes of the Virtual Trials.
- CARO has a webpage dedicated to the Virtual Trials (www.canadianrallyo.ca/page/Virtual_Trial) Everything a participant needs to navigate the trial from entry to reporting results can be found there.

2.0 General Rules

2.1 Eligibility to participate

- Female dogs in season are permitted.

2.2 Course modifications

- Requests must be submitted as indicated on the entry form.
- Participants should refer to the Handbooks for details of when a vet note is required.

2.3 Trial Classes and Streams

- Rally Classes - A and B Streams are combined and reported as B Stream.
- Move ups are allowed. With your video submission identify that it is a move up.

2.4 Trials

- CARO hosts two virtual trials each year. One in the spring and one in the fall.
- For exact dates please refer to the Calendar on the website.
- All information related to the trials can be found on the Virtual Trial section of the website located under the heading 'Trials'.

2.5 Trial Etiquette

- Participants are expected to exhibit responsible pet ownership practices when participating in the virtual trials.
- All relevant municipal bylaws must be followed.

2.6 Titles & Ribbons

2.6.1 Titles

- A link to the form for registering titles earned during trials will be available on the Virtual Trial section of the website.

2.6.2 Ribbons

- Ribbons for individual qualifying scores (Q's) or titles normally presented by trial hosts at in-person trials will not be provided.
 - ◆ Participants may procure their own ribbons.
 - ◆ CARO grants permission for the logo to be used in this case.

3.0 Rally Classes

3.1 All Rally classes are available in the virtual trials.

3.2 Excluded station signs

- The following stations will not be used:
 - ◆ Station 212 - HALT - Stand – Leave for Walk Around
 - ◆ Station 213 - Return to Heel
 - ◆ Station 312 - Broad Jump
 - ◆ Station 313 - Tunnel

4.0 Working Classes

4.1 All Working classes are available in the virtual trial.

4.2 Adjustments to rules for the Working Exercises

- In Retrieve on Flat or Retrieve over Jump
 - ◆ If the object is thrown outside the boundary of the ring, the handler may leave the ring to retrieve the item with the following conditions:
 - If the dog remains in their initial sit from the beginning of the exercise while the handler collects the retrieved item and redoes the next throw, it will count as the same attempt of the exercise.
 - If the dog leaves their initial sit from the beginning of the exercise when the handler goes to retrieve the item, then their attempt is complete and they must either make a second attempt (if available) or move on to the next exercise.

5.0 Setting up

5.1 Ring setup – Rally and Working Classes

- Ring size is 30 feet x 30 feet.
- Ring area must have a prominent marker in each corner and every ten feet along the sides that can be seen easily on the video. There must be 12 markers in total as illustrated below.
- All equipment, markers, boxes and/or lines must be clearly visible to the judge.

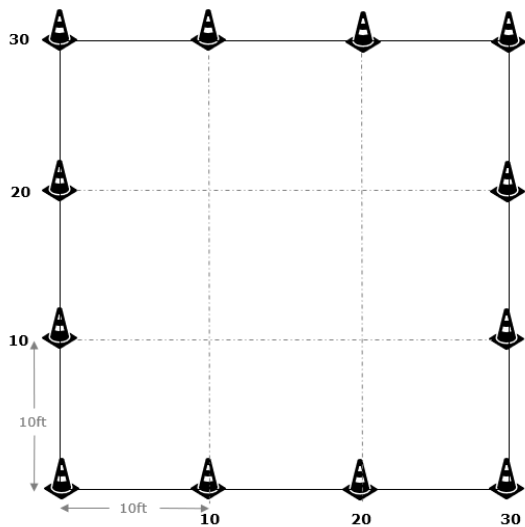

5.2 Station Signs

5.2.1 Station signs must be:

- 8.5x11 letter size or half letter size.
- Printed or handwritten.
- Placed on the ground, taped to cones, or in holders.

5.3 Flooring

- Flooring must be a non-slip surface.
- If, in the opinion of the judge, the dog's performance is affected by the flooring, the run will be given an NQ.

6.0 Rally course setup

- For specific equipment requirements refer to the CARO Handbooks.
- Equipment and Ring Set-Up demonstration https://youtu.be/zdg50_Putn4

6.1 Placement of station signs

- The station signs should be placed as illustrated on the course maps.

6.2 Stations with pylons

- Weave Once and Weave Twice



- Spirals



- Off-Set Figure 8
 - ♦ Food bowls must be security covered so that the dogs cannot access the food.
 - ♦ The food in the bowls must be tempting to the dog.

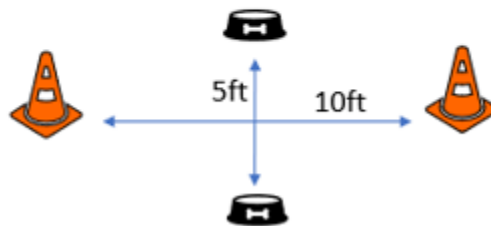

6.3 Rally Obstacles with send zones

- For jumps equivalent substitutes may be used as long as they meet the safety requirements outlined for jumps in the Handbooks.
- The ten-foot line and the lines for the send zone must be clearly indicated and visible on the video.

- The following illustrations assume left sided heeling. Lines are to be placed to the left of the obstacle for right sided heeling.

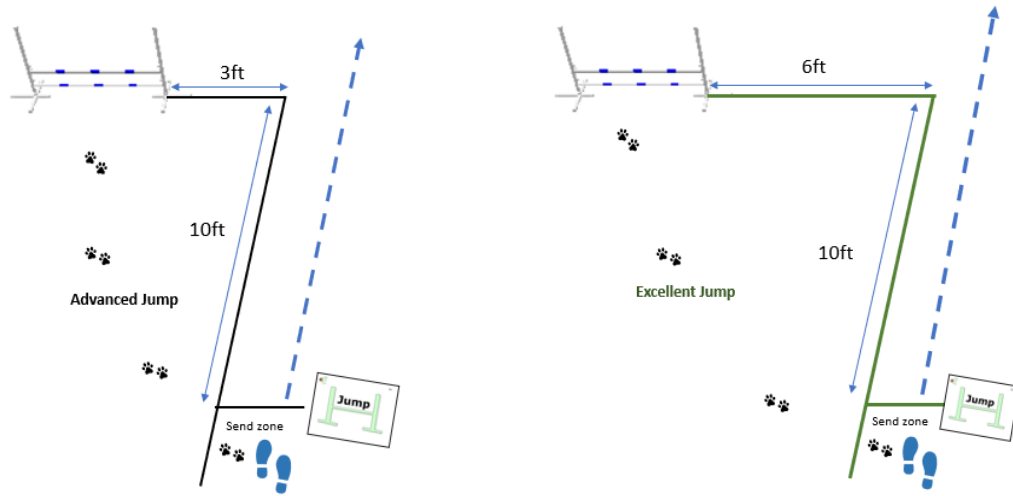

6.4 Setup options for stations with 5ft lines

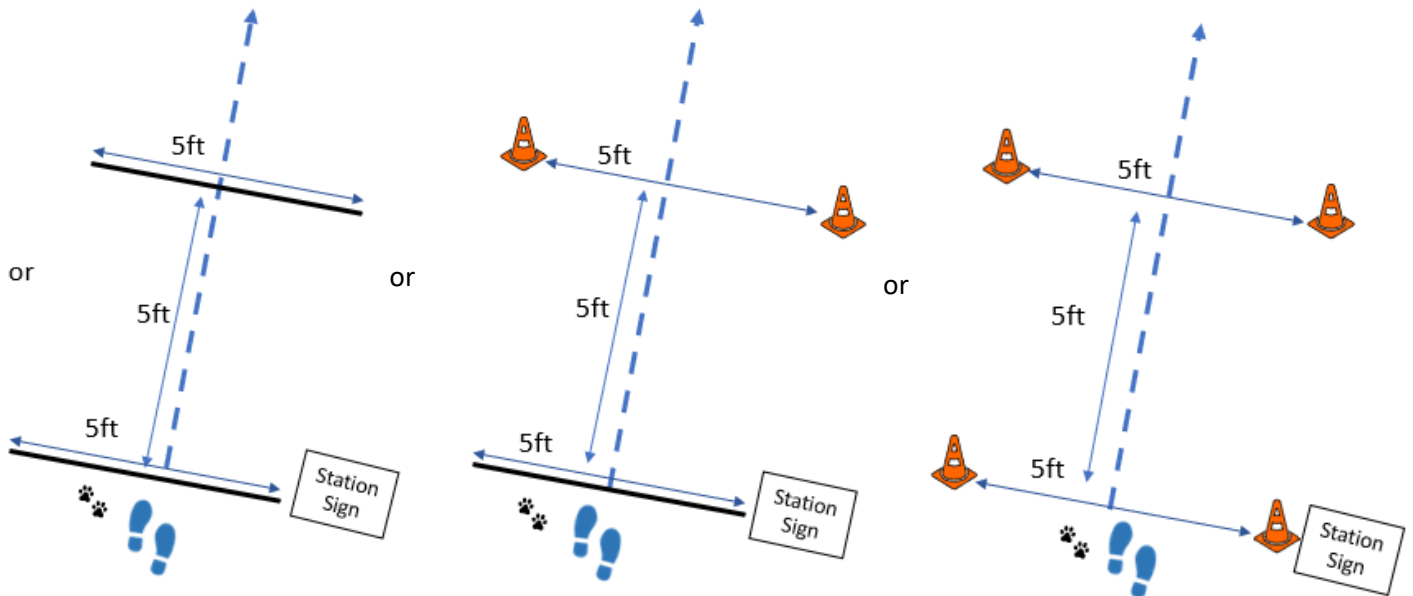

6.5 Adjustment for Brace

- For the Weave Once, Weave Twice and Spirals increase distance between pylons by 12 inches.
- For the Offset Figure 8 increase both the distance between the food bowls and the distance between the cones by 12 inches.

7.0 Working course setup

It is the responsibility of the participant to ensure that the judge can review the performance of the exercises.

7.1 Station Signs

- Station signs are optional.

7.2 Lines and boxes

- Lines and boxes may be constructed using tape, pvc, spray paint, rope secured on all 4 corners, or a similar material that is safe to use and is set up to minimize any tripping hazards.
- Participants are encouraged to use colours which contrast with the floor.
- For the handler box only - A 2ft x 2ft mat may be used.

7.3 Layout of exercises

- For specific equipment requirements refer to the CARO Working Handbook.
- The setup of equipment depends on which exercises are chosen and is up to the participant.
- The Directed Jumping exercise must be placed diagonally from corner to corner.

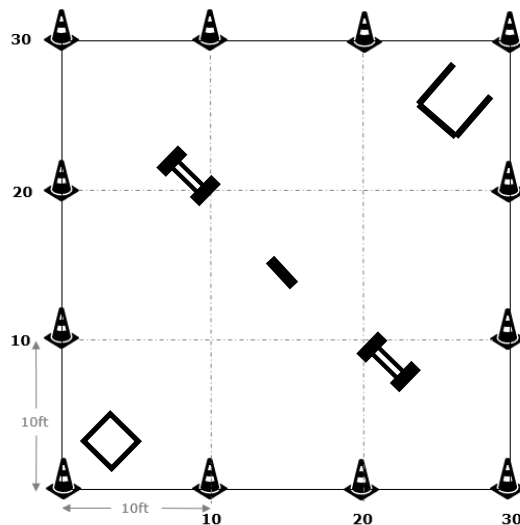

- If both Directed Jumping (DJ) and Retrieve Over Jump (ROJ) are selected one of the Directed Jumping obstacles may be used for the Retrieve over Jump exercise.

- Drop on Recall (W1) and Back Away (W6) must be perpendicular to the camera placement in order to ensure the judge can clearly see the lines and the dog's position. An example is included here:

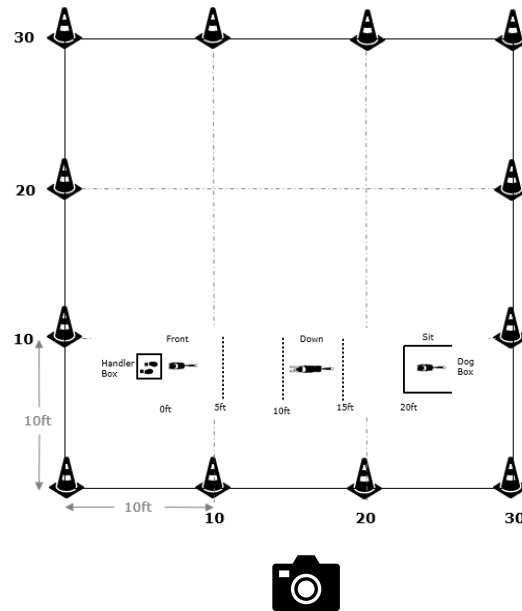

7.4 Managing equipment during the run

- Cones can be set to the side and moved into or out of pre-marked and measured designated areas if needed. No additional time is allotted, dog can be placed in a sit or down or heel with the handler while the ring is being adjusted. A helper can also be used.
- Designated retrieve and scent - Handlers may place the items themselves while the dog stays where they would be when the judge places the items (as described in the Working-Class handbook).

8.0 Videos

8.1 General requirements

- Videos must be recorded during the period of the trial.
- Videos must be clear, stable, and recorded from one stationary position.
 - ♦ The camera may be on a mount or held by a helper.
 - ♦ The video may follow the movement of the team but both the dog and the handler must be fully on screen at all times.
 - ♦ The judge must be able to see the entire ring over the course of the video. Failure to show the entire ring will result in a NQ in Rally or Not Yet for all exercises in working.
- Audio must be turned on and the camera must be placed so the judge can hear the competitor.
 - ♦ The use of wireless headphones with a mic is encouraged for clarity of audio.
- Videos and courses may not be shared or posted on social media prior to trial closing date.

8.2 Preparing to record

- Confirm the camera angle requested by the judge and ensure you are filming from that side of the course.
- Check that the full ring and all lines and markers are clearly visible on video.

8.3 While recording

- Either before starting, or after finishing the course handler must state:
 - ♦ The type of collar or harness the dog is wearing.
 - ♦ The name of the judge.
- Video must include the team entering and exiting the ring
- Video must include the following timings:
 - ♦ In Rally rounds, include a minimum of 5 seconds before passing the START stations and a minimum 5 seconds after passing the FINISH station.
 - ♦ In Working rounds, video must include a minimum of 5 seconds before approaching the first station and at least 5 seconds after ending the final station.
- The dog and the handler must stay within the boundaries of the ring from ring entry to ring exit. This includes when the handler moves any equipment or retrieves the leash at the end of the run.
- For the Team classes the full bodies of both dogs and handlers must always be in the video.
- Ensure that anyone near the ring remains silent. Comments coming from off camera may be considered as outside interference and result in an NQ for rally or a Not Yet in Working.

8.4 Editing

- Any editing of the video other than to trim them to include five seconds before passing the START signs and five seconds after passing the FINISH station will result in an NQ.

8.5 Submitting videos

- All video submissions are final. Participants are strongly encouraged to verify that they are sending the correct video link prior to submitting it to the judge.
 - ♦ Upload videos to YouTube (as “Unlisted”) or Vimeo (as “Private”).
- In the submission email include the following information:
 - ♦ The class, round number, stream (A/B or C for Rally, not applicable for working), dog name, CARO Dog ID # and handler name and identify if the run is a move-up.
 - ♦ The link to the video
 - ♦ Sample: Novice 2, A/B Stream, Fergus, #6294, Sally Smith. <https://youtu.be/xxxxxx>
- Team submissions – submit one email noting both teams’ information and copying the partner team on the e-mail.

9.0 Judging

- Videos will be judged within a few days. The judge will email the competitor a copy of their scoresheet.

10.0 Entry of results

- The virtual trials include multiple rounds of each class. Results are entered into the CARO database in round order.
- All results are dated as of the last day of the trial.
- A Title Achieved Sheet is provided for each virtual trial. The link to the sheet will be made available on the premium list.

ANNEX - Working Exercise Graphics

Drop on Recall

Rookie

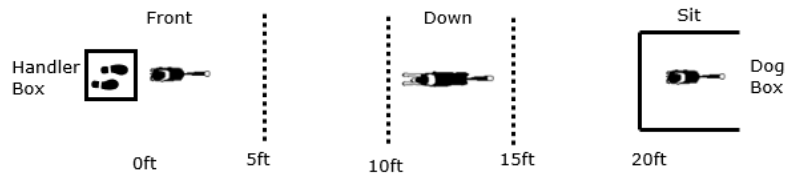

Elite

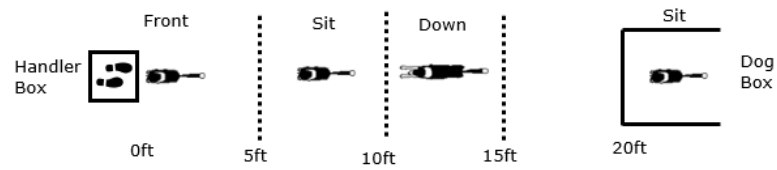

Expert

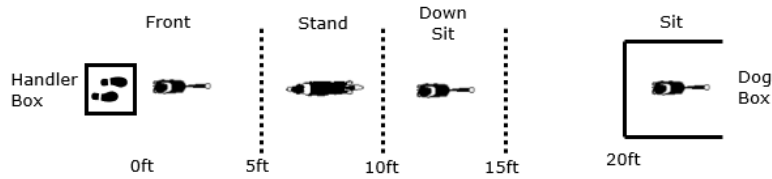

Retrieve on the Flat



Barrel Racing

Rookie

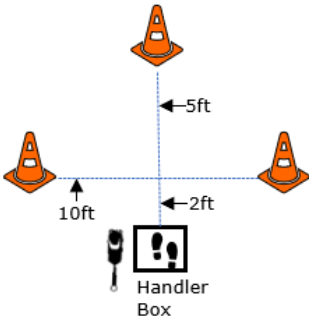

Elite

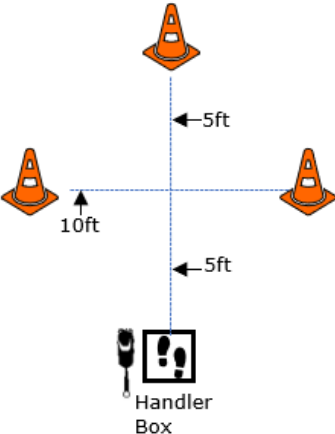

Expert

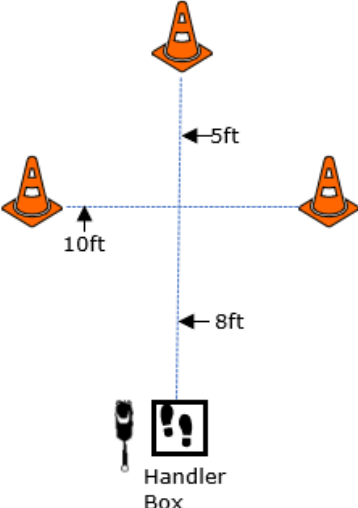

Directed Jumping

Rookie

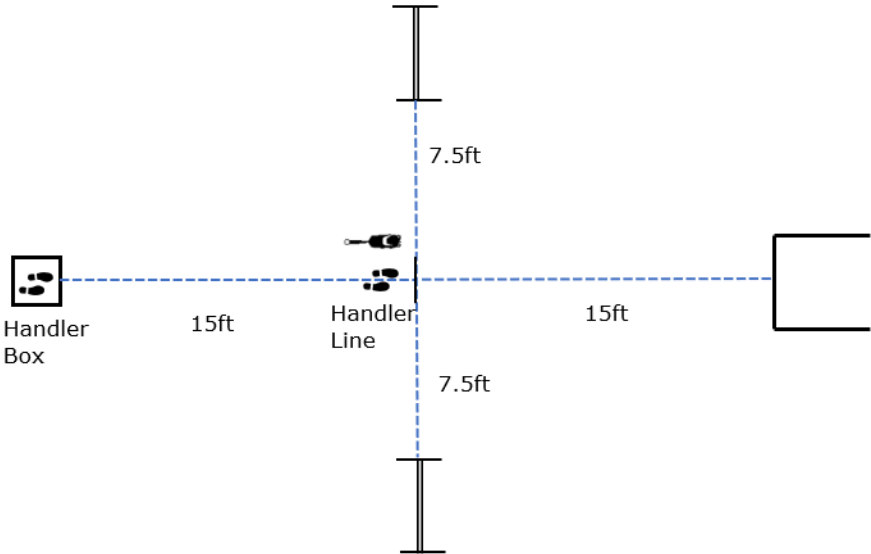

Elite & Expert

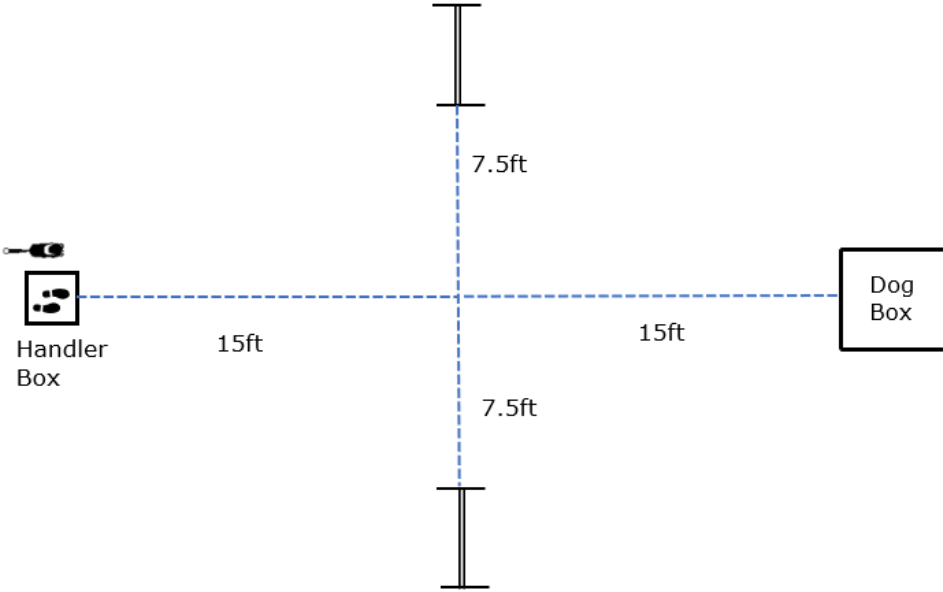

Designated Retrieve

Rookie

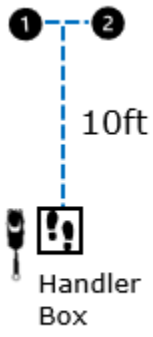

Elite

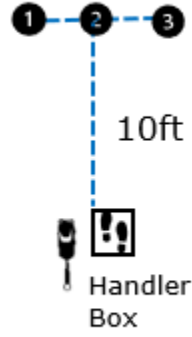

Expert

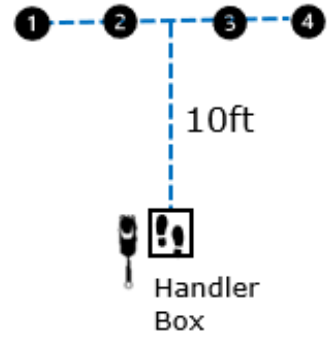

Round the Clock

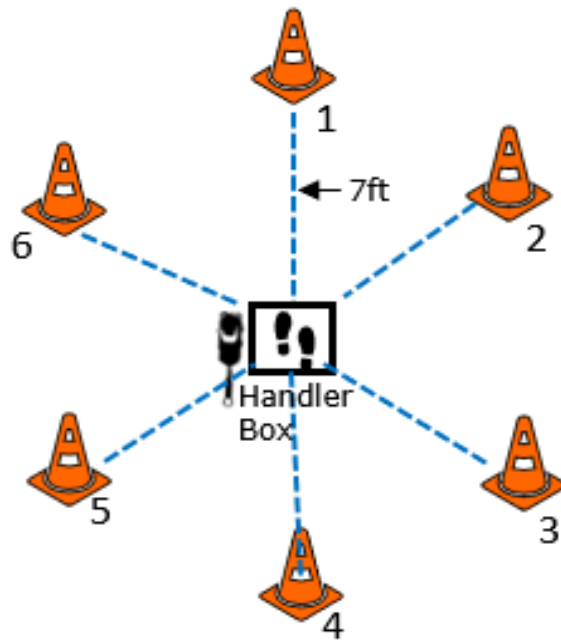

Distance Signals

Rookie

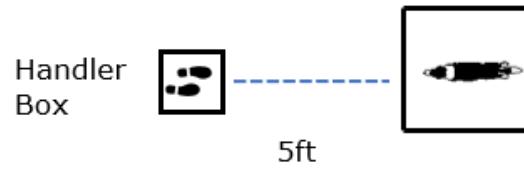

Elite & Expert

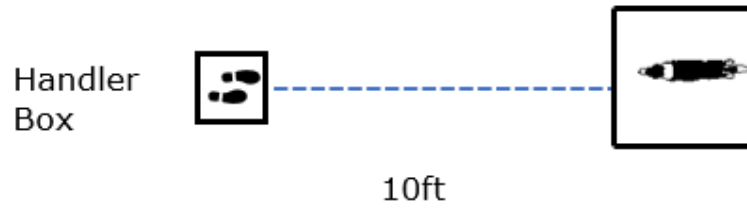

Retrieve over Jump

Rookie

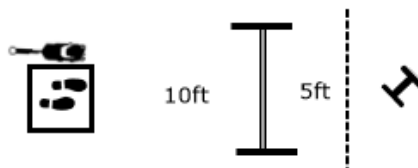

Elite & Expert

